



## 2 Door Wall Unit

### IMPORTANT

Before Commencing Assembly:

- Read all instructions COMPLETELY
- Ensure all listed parts are present  
If any parts are missing from Parts List 1, please contact 1800 822 823.
- If any parts are missing from Parts List 2, please contact 1300 559 387.
- Ensure you have the required tools to complete the assembly  
(Philips Head Screwdriver, Hammer & Wood Glue)

### CAUTION

- Ensure your work surface is solid, level, clean and flat (DO NOT WORK ON CARPET)
- Ensure ALL melamine edges are facing as described in the Assembly Instructions.

IF YOU NEED TO CONTACT US WITH REGARD TO THIS PRODUCT PLEASE CALL **1800 822 823** AND QUOTE THE BATCH NUMBER SHOWN ON THE CARTON.

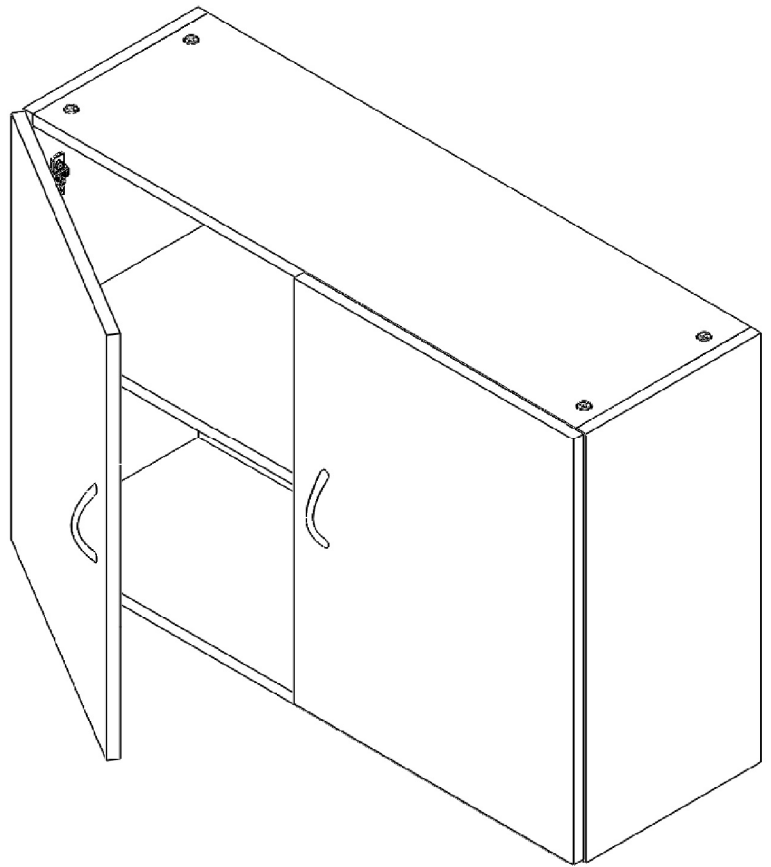

**WARNING: Contains small parts, keep out of reach of children.**

615 Goodwood Road, Panorama SA 5041  
PO Box 18 Melrose Park SA 5039  
Telephone: 1800 822 823, Fax: (08) 8460 0009  
Email: [furniture@bedfordgroup.com.au](mailto:furniture@bedfordgroup.com.au)  
[www.bedfordgroup.com.au](http://www.bedfordgroup.com.au)



Quality  
ISO 9001

SAI GLOBAL



AUSTRALIAN MADE

**Practical, Adaptable, Affordable.**

READY TO ASSEMBLE HOME STORAGE SOLUTIONS

# Parts List 1

## 2 Door Wall Unit

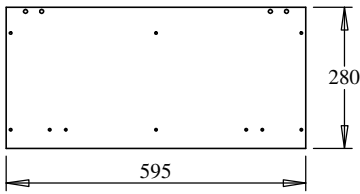

Part No.	Description	Qty.
1	Cabinet End	2

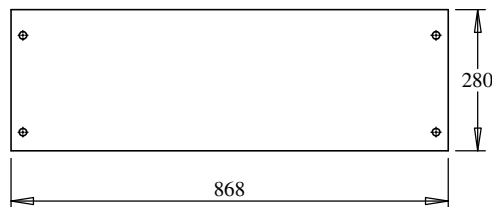

Part No.	Description	Qty.
2	Top/Fix Shelf/Bottom	3

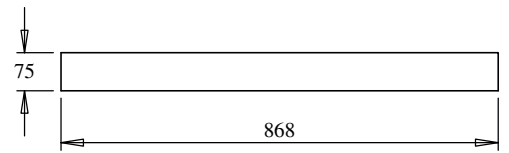

Part No.	Description	Qty.
3	Rails	2

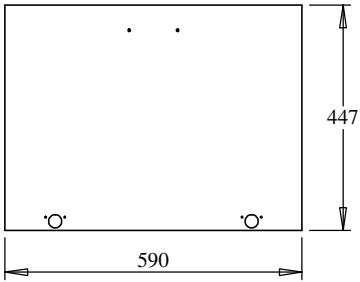

Part No.	Description	Qty.
4	Door	2

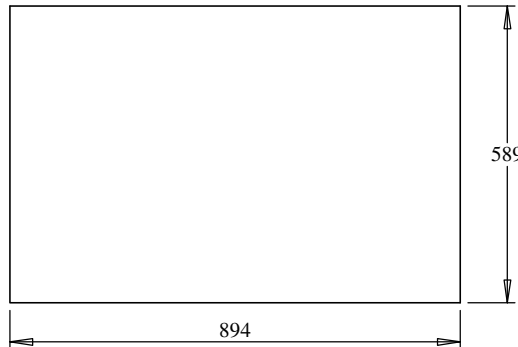

Part No.	Description	Qty.
5	Back	1

## Parts List 2

### 2 Door Wall Unit

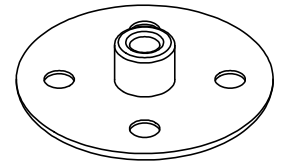

Part No.	Description	Qty.
15	Cover Caps	12

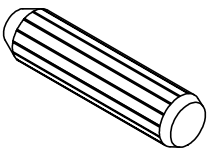

Part No.	Description	Qty.
6	Wooden Dowels	8

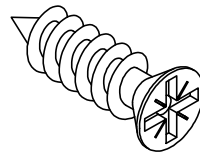

Part No.	Description	Qty.
7	Hinge Screw (15mm)	8

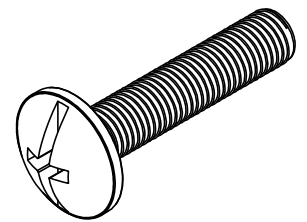

Part No.	Description	Qty.
8	Handle Screw	4

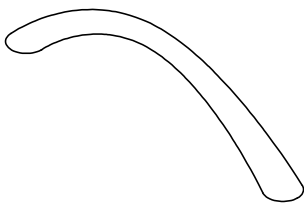

Part No.	Description	Qty.
9	Handle	2

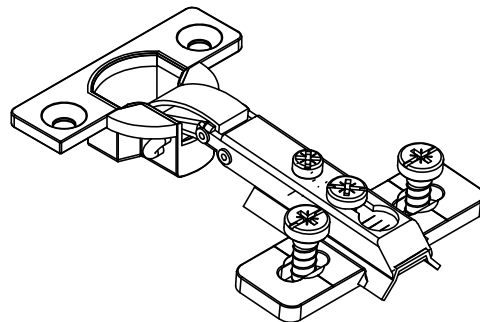

Part No.	Description	Qty.
10	Hinge	4

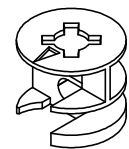

Part No.	Description	Qty.
11	Screw Cams	12

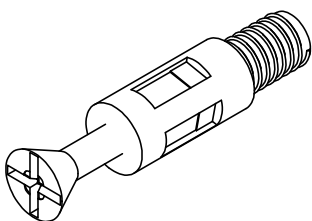

Part No.	Description	Qty.
12	Hardware Pins	12

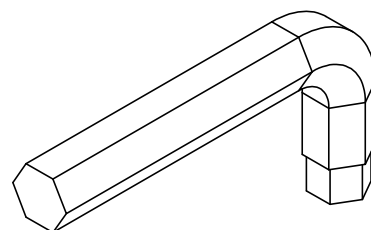

Part No.	Description	Qty.
13	Allen Key (4mm)	1

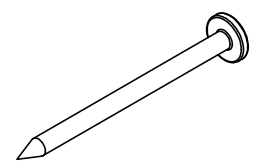

Part No.	Description	Qty.
14	Nails	50

### Step 1

#### Cabinet end panels

Lay the cabinet end panel (1) on a flat protected surface with holes facing up. Please note that the left and right end panels are reversible. Screw the hardware pins (12) in the holes shown.

Repeat the step for other cabinet end panel (1).

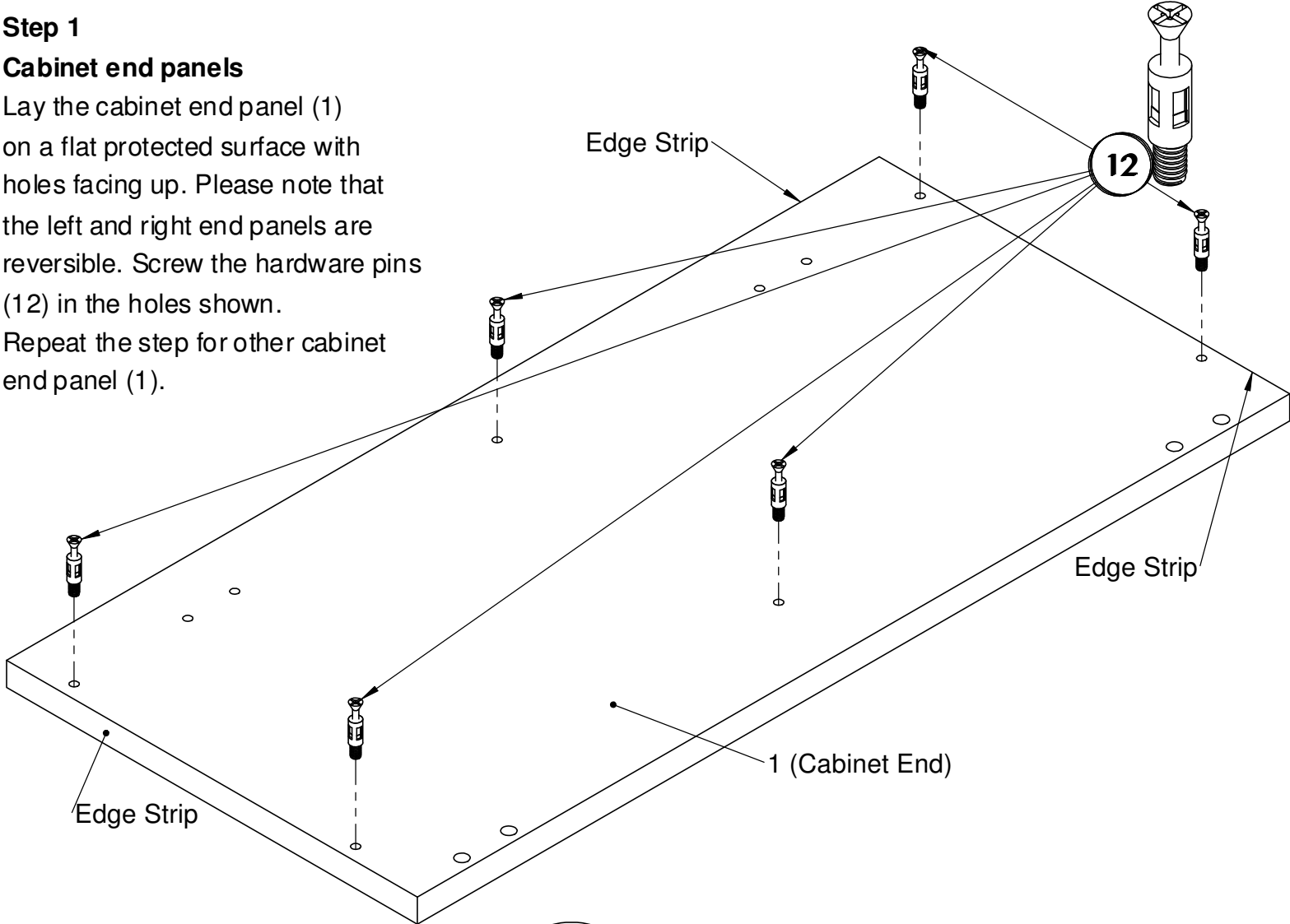

### Step 2

#### Top, bottom and fix shelf

Lay the top (2) on a flat protected surface with holes facing up and insert the cams (11) in the holes with arrows pointing to the side as shown. Please note that top, fix shelf and bottom are same. Make sure to push the cams (11) all the way in by gently tapping them in with a hammer.

Repeat the step for fix shelf (2) and bottom (2).

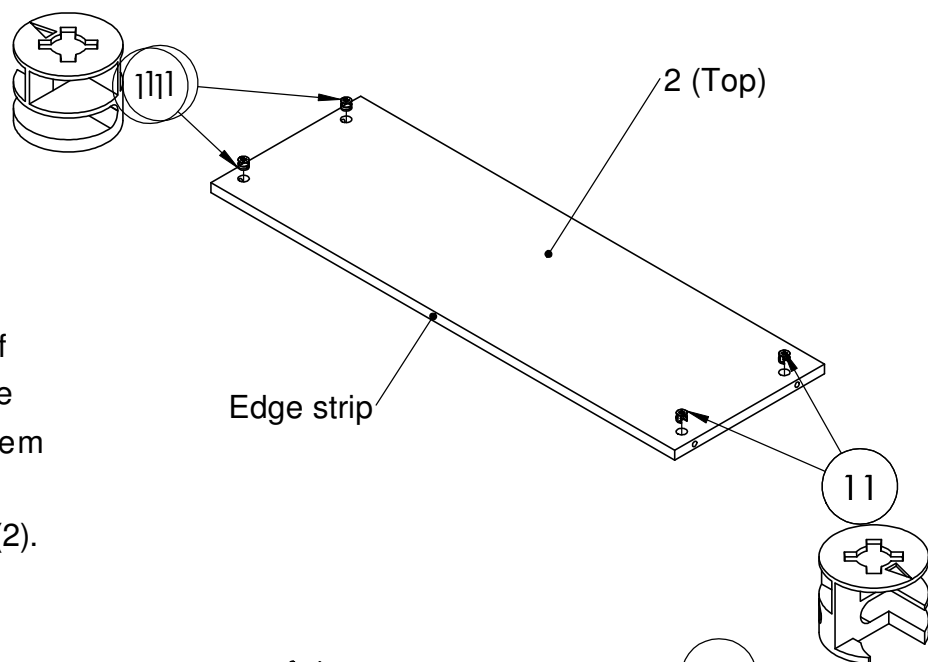

### Step 3

#### Inserting dowels into rails

Please insert wooden dowels (6) into the rail (3). It is recommended to use glue prior to inserting wooden dowels into rails (please remove excess glue with a damp cloth). Make sure to push the dowels (6) all the way in by gently tapping them in with a hammer.

